

Gauss and Weber's Creation of The Absolute System of Units In Physics

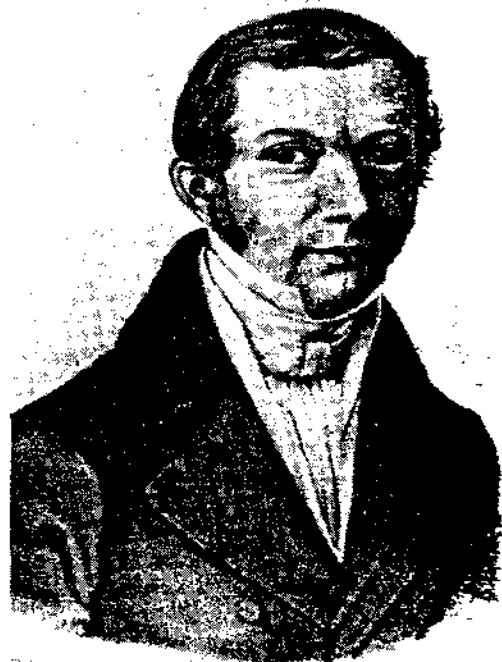

Museum of the City of Göttingen

Wilhelm Weber (1804-1891). Physics professor in Göttingen from 1831; expelled by the King Ernst Augustus in 1837.

by Andre Koch Torres Assis, Karin Reich, and Karl Heinrich Wiederkehr

A specialist in Weber's electrodynamics, and leading biographers of Weber and Gauss, tell how Gauss's 1832 work in magnetism changed physics, and led to Wilhelm Weber's development of the laws of electricity.

Here we discuss the work of Carl Friedrich Gauss (1777-1855) in magnetism, centering our analysis in his work of 1832 and its consequences for physics.¹ We also analyze the extension of this line of research accomplished by Gauss's collaborator Wilhelm Eduard Weber (1804-1891).²

Electricity and magnetism had become very active fields by the 1830s, when Gauss turned his full attention to them. The science of Earth magnetism, which until then had been isolated from other fields, suddenly became a center of attention when the close connection between magnetism and the science of electricity was discovered. Hans Christian Oersted had discovered electromagnetism in 1819; Thomas Johann Seebeck discovered thermoelectricity in 1821; A.M. Ampère developed in the 1820s his famous work of the interaction between current elements; and Michael Faraday described electromagnetic induction in 1831. Ampère interpreted all magnetic phenomena as the interaction between currents, and hypothesized the existence of micro-currents within the particles of magnetized

bodies. A "terrestrial current" flowing over the surface of the Earth from east to west, according to Ampère, would force a magnetic compass needle to its orientation.

Beyond this general interest in the themes of magnetism and electromagnetism, there were two key factors which motivated Gauss to initiate his real work in this field: the direct influence of Alexander von Humboldt (1769-1859) and that of his collaborator, Wilhelm Weber, who filled the vacant chair of physics in Göttingen in 1831. Humboldt had already created a European network of regular, synchronous magnetic observations (Ref. 8). In a letter to Weber from Paris at the end of 1831, Humboldt expressed the wish that Göttingen could also participate in the simultaneous observations (Ref. 9). The meaning of this letter was recognized and first quoted by K.H. Wiederkehr (Ref. 10).

In 1828, Humboldt organized and presided over the Meeting of the German Association of Natural Scientists and Doctors, which took place in Berlin. Gauss was his personal guest in this Conference. Weber also took part, and it was here that he met Gauss for the first time (see Ref. 2, p. 32). Three years later, Weber was nominated to the chair of physics at Göttingen University, based on an expert judgment written by Gauss (Ref. 11). At this time Gauss was 54 years old and Weber 27. Gauss could then realize his project with the help

EDITOR'S NOTE: *Although we disagree with the Newtonian standpoint of our friend Dr. Assis, we print the following in furtherance of a dialogue on the subject, and its important implications for understanding the Ampère-Gauss-Weber electrodynamics.*

Cover page of Gauss's famous work "The Intensity of the Earth's Magnetic Force Reduced to Absolute Measurement" (1832), in which the absolute system of measurements (triple system) was founded.

INTENSITAS
VIS MAGNETICAE TERRESTRIS

AD MENSURAM ABSOLUTAM REVOCATA.

COMMENTATIO

AUCTORE

CAROLO FRIDERICO GAUSS

IN CONSESSU SOCIETATIS MDCCCXXXII. DEC. XV. RECITATA.

Commentationes societatis regiae scientiarum Göttingensis recentiores. Vol. VIII.
Göttingae MDCCCXXXI.



Museum of the City of Göttingen

Carl Friedrich Gauss (1777-1855). Among the greatest mathematicians of all time, he also carried out pioneering research in astronomy, surveying, and experimental physics.

from Wilhelm Weber, an already experienced and ingenious experimental physicist. The wisdom of the older was thus connected with the energy of the younger.

Gauss's Seminal Paper

We now turn to the first fruit of Gauss's work in magnetism. On December 15, 1832, Gauss read his famous treatise, *Intensitas vis magneticae terrestres ad mensuram absolutam revocata* (The intensity of the Earth's magnetic force reduced to absolute measurement), before the meeting of the Göttingen Scientific Society. As Gauss states in this treatise, he was assisted by Wilhelm Weber in many ways in undertaking this work. The original article in Latin was published in 1841 and is reprinted in Gauss's Collected Works (Ref. 12). There are two different German translations, one of 1833 and one of 1894 (Refs. 13, 14). In the published German version of 1833 it is not stated who was the translator. But we know that it was J.C. Poggendorf, the editor of the *Annalen der Physik und Chemie*, as this was stated by Gauss in a letter to H.C. Schumacher in 1845 (see Ref. 15, pp. 436-440). In this letter, Gauss also stated that he considered it a bad translation. There are also other translations: French (1834), Italian (1838), Russian (1952) and an unpublished English translation (see Refs. 16, p. 35; 17; and 18, Note).

In order to explain magnetic phenomena, Gauss assumes in

the *Intensity* the existence of two magnetic fluids (north/positive and south/negative), following the ideas of Coulomb and Poisson (see Ref. 19, pp. 57-65). According to Gauss, these fluids are associated with the ponderable particles of the body where they are located, attracting (opposite signs) or repelling (same sign) one another according to the inverse square of the distance. Only in the last section of the *Intensity* does Gauss mention the possibility of explaining magnetism by assuming the existence of electric currents around the particles of the magnetic body. This last idea is that of Ampère (see Ref. 20, with partial English translation in Ref. 21), although Gauss does not mention his name.³

There are two main aspects of this work which made it epoch-making. The first is the reduction of magnetic magnitudes to mechanical ones, the so-called absolute system of units introduced here by Gauss. The second is the effective measurement of the magnetic properties of the Earth and of a magnetized needle with an accuracy until then unattainable. The term "absolute measurement" in the title is here in opposition to "relative measurement." In his travels through America and Russia, Alexander von Humboldt had performed regular magnetic measurements, determining the Earth's magnetic intensity by counting the oscillations of a bar magnet (magnetized needle). Humboldt assumed the constancy of the

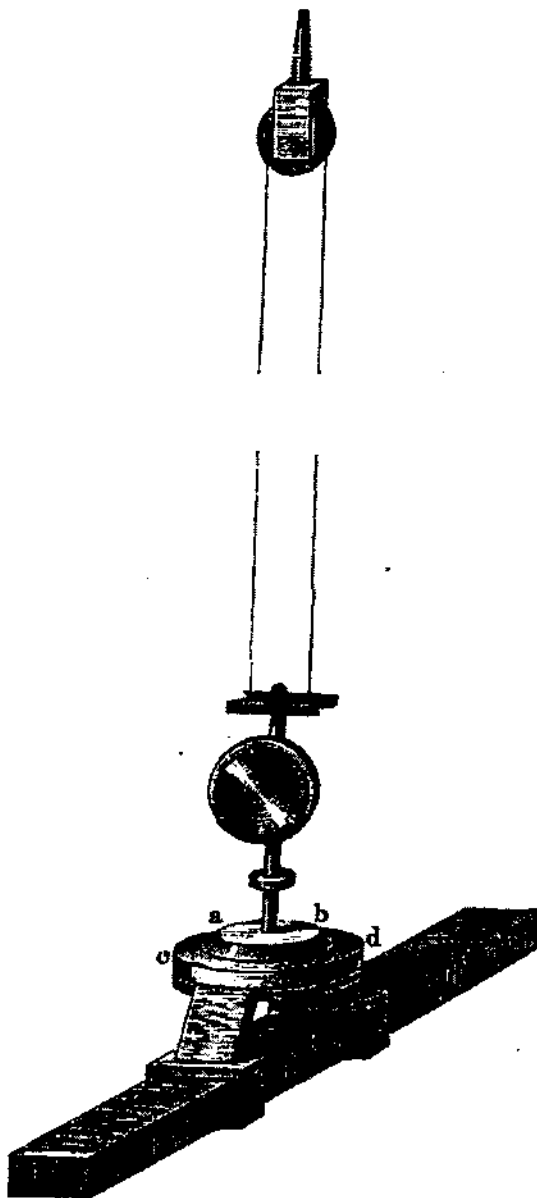

Gustav Wiedemann, *Die Lehre von der Elektrizität*, Vol. 3 (1894), p. 344

A great bar magnet weighing several kilograms from one of Gauss's magnetometers, shown here with bifilar suspension and mirror. The mirror reflected the image of a meter stick mounted atop a telescope placed a few meters away. By this means, the angle of deflection of the magnet could be determined with astronomical accuracy.

magnetic moment of the needle. This magnetic moment \vec{M} is the product of the distance between the poles of an (ideal) magnet by the magnetic fluid in the positive pole. The magnetic fluid corresponds to the "free magnetism." The direction of \vec{M} is along the axis of the bar magnet pointing from the negative pole to the positive one. The period of oscillation of a magnet is proportional to the square root of the intensity of the magnetic field acting on the bar.⁴

Humboldt determined that the intensity of the Earth's mag-

netic field increased from the magnetic equator toward the magnetic poles. He compared all intensities with the intensity of the magnetic field at the magnetic equator, which he assumed to have intensity equal to 1 (see Ref. 10). In his measurements it was assumed that the magnetic force of the bar (its magnetic moment) was constant, which is not at all certain. This magnetic moment of the needle, the magnetic field where it was oscillating (for Humboldt and Gauss it was the Earth's magnetic field), or both of them, can change with time. In order to make exact comparisons of the magnetic field of the Earth at one location at different periods of time separated by a great time interval, another method is necessary.

Gauss's Solution

The period of small oscillations of a magnetized needle around an axis orthogonal to a constant and uniform magnetic field H is given by $2\pi \sqrt{I/MH}$, where $M = |\vec{M}|$ and I is the moment of inertia of the needle (see Ref. 27, p. 19). By measuring this period of oscillation and the moment of inertia of the needle oscillating under the influence of the Earth's magnetic field H , it is possible to obtain the product MH . In order to obtain M and H separately, one must also measure their ratio H/M . This can be done using a second needle as an auxiliary, which is exposed both to the influence of the Earth's magnetism and of the first needle. In the first case, one isolates the effect on the second needle of the Earth's magnetic field. In the second case, one measures the effect on the second needle of the combined influence of the Earth's magnetic field and the magnetic field of the first needle, which is proportional to its magnetic moment. By combining these two cases it is then possible to ascertain the ratio H/M . With the previously measured value of MH , it is then possible to obtain separately the values of M and H , as desired (Figure 1).

In the seventh paragraph of the *Intensity*, Gauss describes two methods for measuring the effects of the Earth's magnetism (with and without the presence of the first needle) on the second auxiliary needle. The first method, which had been proposed by Poisson in 1828, is to observe the oscillation of the second needle (Ref. 27, pp. 23-27). However, Gauss does not employ this method in the *Intensity*, because of the inaccurate results which it had so far produced. Instead, he proposes and carries out measurements by a second method, which he developed independently of Poisson, consisting in observing the second auxiliary needle in states of equilibrium. Gauss described it as follows:

In the second method, the first needle is placed so that the direction of the force, which it exerts on the location of the second, freely suspended, needle, forms an angle (for example, a right angle) with the magnetic meridian; by this means the second needle itself will be deflected out of the magnetic meridian, and from the magnitude of the deviation, one can infer the relation between the terrestrial magnetic force and the influence of the first needle [Ref. 17].

By the application of this second method, Gauss determined with high precision, both the Earth's magnetic field strength and the magnetic moment of the needle which he had used. A good

description of his procedure can be found in Ref. 27, pp. 17-23.

We now want to emphasize a very important and new aspect introduced by Gauss in this work. In the *Principia* (1687), Newton introduced the law of gravitation in terms of proportionalities (see Ref. 28, Book I, Props. 72 to 76; Book III, Props. 7, 8; and General Scholium; and Ref. 29, pp. 20-21). In particular, he showed that the gravitational force between two bodies is proportional to the product of their masses and inversely proportional to the inverse square of their distance. Coulomb in 1785 arrived at the fundamental laws of electrostatics and magnetostatics also expressing himself in terms of proportionalities (see Refs. 30, 31; and 29, pp. 244-245). Coulomb assumed the magnetic attractions and repulsions to be proportional to the densities of the magnetic fluids, and demonstrated experimentally that they are inversely proportional to the square of their distance of separation.

By the beginning of the 19th Century, scientists were expressing these laws in terms of equalities. To this end, they introduced proportionality factors (constants) into the laws of gravitation, electrostatics, and magnetostatics, which depended on the system of units employed. Poisson (1825), for instance, wrote the magnetic force F between two magnetic fluids, m_1 and m_2 , separated by a distance r as $F = fm_1m_2/r^2$ (for discussion, see Refs. 27; pp. 11-12 and 23-25). Gauss was the first to specify the value $f = 1$ dimensionless to this proportionality factor in his work *Intensity*. This appears in the first section of this work, which merits quoting here in full:

To explain magnetic phenomena, we assume two magnetic fluids: one we call north, the other south. We presuppose, that the elements of the one fluid attract those of the other, and that on the other hand, two elements of the same fluid mutually repel each other, and that each of the two effects alters in inverse relation to the square of the distance. It will be shown below that the correctness of this law was itself confirmed by our observations.

These fluids do not occur independently, but only in association with the ponderable particles of such bodies which take on magnetism, and their effects express themselves either when they put the bodies into motion or they prevent or transform the motion, which other forces acting on these bodies, e.g. the force of gravity, would elicit.

Hence the effect of a given amount of magnetic fluid on a given amount of either the same or the opposite fluid at a given distance is comparable to a given motive force, i.e. with the effect of a given accelerating force on a given mass, and since the magnetic fluids themselves can be known only through the effects, which they bring forth, the latter must directly serve to measure the former.

In order, however, that we may be able to reduce this measurement to definite concepts, units must above all be established for three kinds of magnitudes, namely, the unit of distance, the unit of ponderable mass, and the unit of acceleration. For the third, the gravity at the locus of observation can be assumed: if, however, this is not suitable, the unit of time must also enter in, and for us that acceleration will be = 1, which, within the time unit, produces a change of velocity of the body in the direction of its motion, which is equivalent to the unit.

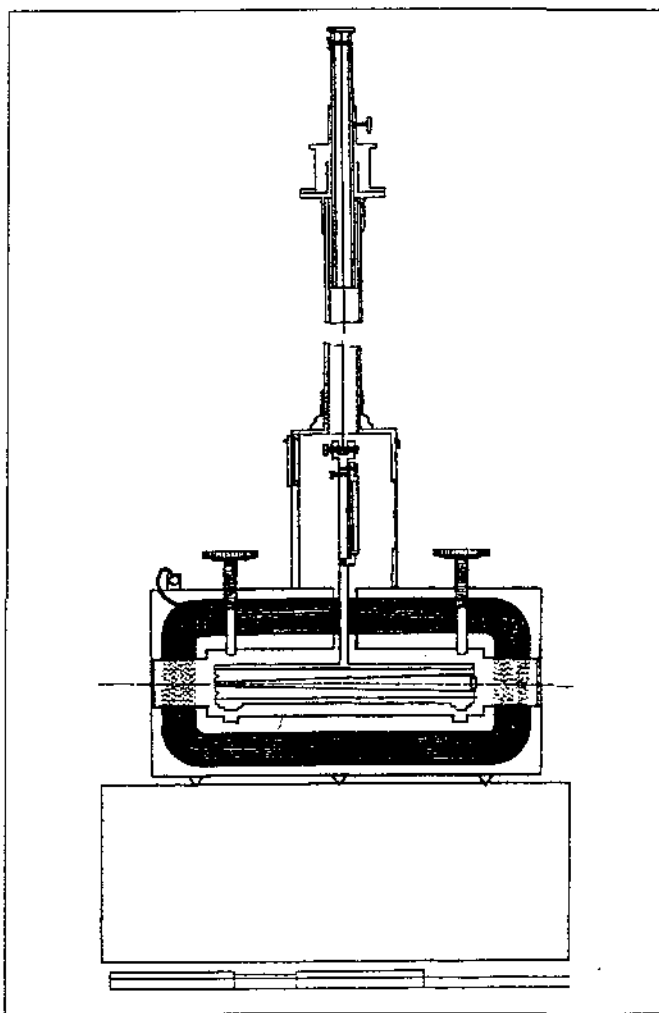

From Wilhelm Weber's Werke, Vol. 2, p. 89 (plate VI, between pp. 118 and 119)

The transportable magnetometer of Wilhelm Weber (1838). A suspension wire runs down the upper tube to a vertical rod holding the mirror (shown in profile). At the bottom, the rod connects to a magnet. This handy instrument served a double purpose. Aside from making magnetic measurements, the coil surrounding the magnet permitted galvanic measurements.

Correspondingly, the unit of the amount of north fluid will be that whose repulsive effect on another like it, and whose existing amount of motive force in the unit of distance = 1, i.e. the effect of an accelerating force = 1 on a mass = 1; the same will be true of a unit of the amount of south fluid; in this definition, clearly the active fluid, as well as that of the effect, must be thought of as, at bottom, united in physical points. Beyond this, however, it must be assumed, that the attraction between given quantities of different kinds of fluids at a given distance is equal to the repulsion between the same respective quantities of the same kind of fluid. Hence the effect of a quantity m of north magnetic fluid on a quantity m' of the same fluid at distance r (each of the two fluids being assumed to be united as at one point) will be expressed as mm'/rr , or it is equivalent to a motive force = mm'/rr , which acts in the direction of

the first against the second fluid, and evidently this formula holds true in general, when, as from now on we wish to stipulate, a quantity of southern fluid will be considered as negative, and a negative value of the force will signify attraction. Hence if equal quantities of north and south fluid are found simultaneously at one physical point, no effect at all will arise; if, however, the amounts are unequal, only the remainder of the one which we wish to term free magnetism (positive or negative) will come under consideration [Ref. 17].

In analytical mechanics it was already common to express all magnitudes based on the three basic units of length, mass and time; for Gauss these were the millimeter, (mm), the milligram, (mg), and the second, (s). For example, a unit force was that which acting on a constant unit mass generated a unit acceleration. Based on Coulomb's law, which described the interaction between magnetic poles, Gauss extended these



Laurence Hecht

The electro-dynamometer used by Wilhelm Weber to prove the validity of Ampère's fundamental law for closed currents. It consisted of a rotatable coil, and a second coil which fit inside the rotatable one (as shown) but could also be placed in other positions outside it. The rotatable coil has a bifilar suspension and mirror. The electro-dynamometer could also perform measurements of alternating currents. The device is preserved in the museum of the Physical Institute at Göttingen.

three basic units to the realm of magnetism.

In essence, Gauss was able to define and measure with great precision the magnetic moment of a magnetized needle and the intensity of the Earth's magnetic field, using only the units of distance, mass, and time. The core of Gauss's expression of magnetic magnitudes based on mechanical ones lies in his operational definition that a unit of magnetic pole is that quantity which generates a unit force when acting on an equal unit magnetic pole separated from the first by a unit distance.

Gauss also defined a unit intensity of the magnetic force (or a unit magnetic field as we would say today), as the intensity which acting on a unit pole generates a unit force. In Section 26 of the *Intensity*, for instance, he wrote down the basic equation describing the interaction between magnetic poles as: $mm/rr = w = pa$, where m is the number describing the quantity of magnetic fluid acting on another equal quantity separated by a distance r and exerting a force w (which he equated to pa , and where p is the constant mass of the body experiencing the force and a its acceleration).

As there are no isolated magnetic poles in nature, the following equivalent definition was also frequently employed: there is a unit intensity of magnetic field when a magnet with a unit of magnetic moment is acted upon by a torque (turning moment) of intensity 1, caused by this supposed constant and uniform magnetic field acting orthogonal to the magnetic axis of the magnet. In this way, it was not necessary to introduce a specific dimension describing a magnetic pole.

Another advantage of Gauss's proposal is that many physical laws take a very simple form, without arbitrary universal constants (such as ϵ_0 and μ_0 used in the International System of Units, MKSA, for example). Later, this triple-system of units was called an absolute system of measurement. The triple-system has proven its utility over a long time. Despite some variation, the International System of Units is based essentially on the absolute electromagnetic system of units introduced by Gauss and Wilhelm Weber

Gauss and Weber

Wilhelm Weber absorbed these ideas of Gauss completely and turned them into reality with his life's work. In the joint research in electricity and magnetism, which the two carried out from 1831 onward, it is sometimes difficult to distinguish the contributions of one from the other. Weber followed the procedures of Gauss in the electromagnetic system of units and measurements which he created. In an article of 1840, published in 1841, Weber introduced the first definition of the absolute electromagnetic unit of current making use of the magnetic effect of a closed current acting on a magnetized needle (Ref. 32). A more precise definition was given in 1842 (Ref. 33). A current with one electromagnetic unit will be the current which flowing in a circuit of plane area 1 exerts the same effect as a magnet with magnetic moment equal to 1. Another statement of this definition he presented in 1851:

As an absolute unit of intensity, can be understood the intensity of that current which, when it circulates through a plane of the magnitude of the unit of measure, exercises, according to electro-magnetic laws, the same action at a distance as a bar-magnet which contains the

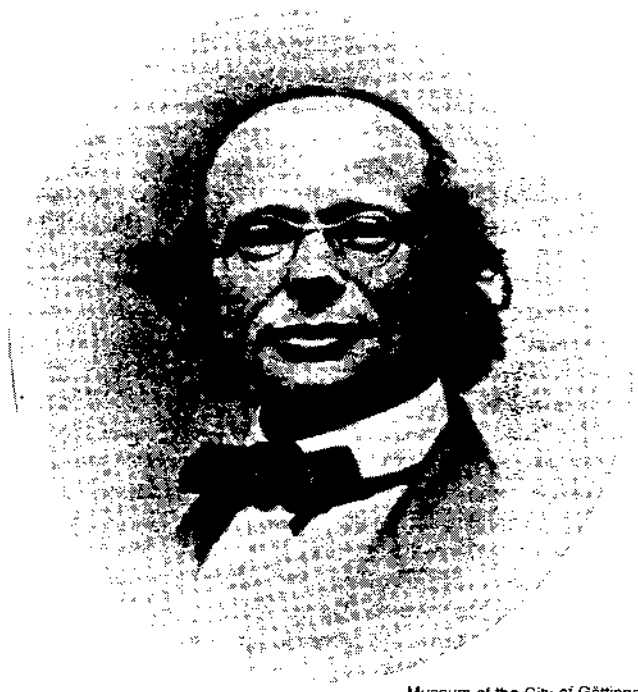

Museum of the City of Göttingen

Wilhelm Weber around 1855 at the time of the famous experiment with Kohlrausch.

unit of measure of bar magnetism [Ref. 34 with English translation in Ref. 35].

Maxwell expressed this as follows:

It has been shown by numerous experiments, of which the earliest are those of Ampère, and the most accurate those of Weber, that the magnetic action of a small plane circuit at distances which are great compared with the dimensions of the circuit is the same as that of a magnet whose axis is normal to the plane of the circuit, and whose magnetic moment is equal to the area of the circuit multiplied by the strength of the current [Ref. 36, Art. 482, p. 141].

In 1851 and 1852, Weber introduced the absolute electromagnetic units of electromotive force (tension) and of resistance (Refs. 34, 35, 36). For the absolute measure of electromotive force in electromagnetic units, he defined:

[T]hat electromotive force which the unit of measure of the Earth's magnetism exerts upon a closed conductor, if the latter is so turned that the area of its projection on a plane normal to the direction of the Earth's magnetism increases or decreases during the unit of time by the unit of surface [Ref. 35].

For the absolute measure of resistance in electromagnetic units, he utilized Ohm's law (1826). The definition runs as follows:

[T]hat resistance can be taken as unit of measure,

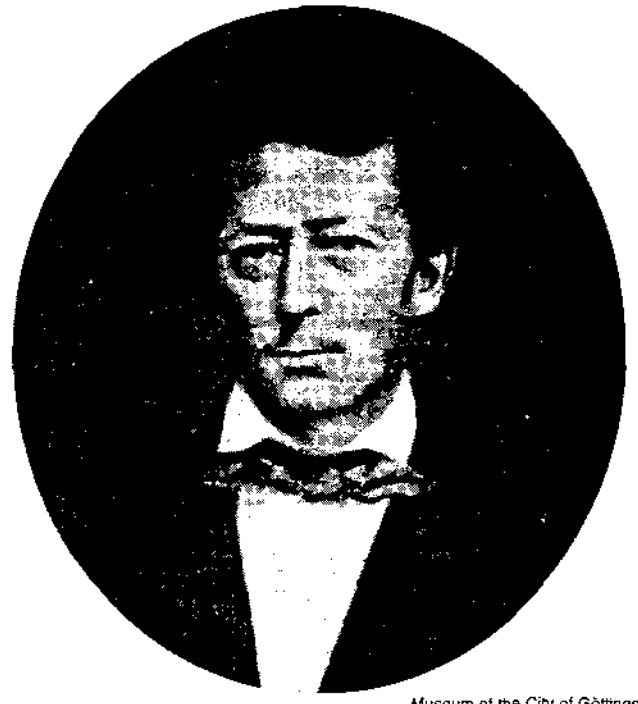

Museum of the City of Göttingen

Rudolf Kohlrausch (1809-1858), one of the leading physicists for electrostatic measurements in this period.

which a closed conductor possesses in which the unit of measure of electromotive force produces the unit of measure of [electric current] intensity. (Ref. 35).

Weber also developed special methods for the determination of electric resistance which were employed for many years.

In 1846, Weber introduced the electrodynamic unit of current by means of Ampère's force between current elements; see Refs. 38 and 39 with English translation in Ref. 40, which is $1/\sqrt{2}$ times the absolute electromagnetic unit. And this is the origin of the factor 2 which appears in the definition of the unit of current (called ampère) in the International System of Units.

By analogy with what Gauss had done for magnetostatics, Weber defined the electrostatic unit of charge by means of the electrostatic force between two charges, expressed with coefficient 1 unitless, expressing this force as ee'/r^2 , where e and e' are the point charges separated by the distance r (Refs. 41-43):

The unit of electrical fluid is determined in electrostatics by means of the force with which the free electricities act on each other at a distance. If one imagines two equal amounts of electricity of the same kind concentrated at two points, whose distance is the unit of length, and if the force with which they act on each other repulsively, is equal to the unit of force, then the amount of electricity found in each of the two points is the measure or the unit of free electricity [Ref. 42].

By supposing the galvanic currents to be the result of the motion of charges, Weber was able to make a definition of current intensity related to the amount of charges flowing over the cross-section of the circuit. It should be observed that Weber

assumed the Fechnerian hypothesis of a double current in a conductor (positive and negative charges moving with equal and opposite velocities relative to the wire). His mechanical measure of current intensity is not identical with the absolute electrostatic measure of current intensity, in which one unit of electrostatic charge flows in one second over the cross-section of a conductor. In the unit of current intensity in Weber's mechanical measure, a positive and also a negative electrostatic unit of charge flows through the cross-section:

This measure, which will be called the mechanical measure of current intensity, thus sets as the unit, the intensity of those currents which arise when, in the unit of time, the unit of free positive electricity flows in the one direction, an equal amount of negative electricity in the opposite direction, through that cross-section of the circuit [Ref. 42].

The unit of current intensity according to Weber's mechanical measure is thus twice as great as the unit of the current intensity in the absolute electrostatic system of measure. For this reason, Weber and Kohlrausch, by forming the quotient of the measured electrostatic and electromagnetic charges, obtained only (approximately) half the value of the velocity of light in vacuum, in their famous 1855 experiment (Refs. 44 and 41, with English translation in Refs. 42 and 45).

In order to arrive at the electrostatic charge, one must multiply by 2 the value of the flowing "mechanical" electrical charge which produces the magnetic field acting upon the small magnet in the tangent galvanometer (from which the intensity of the current in electromagnetic units is determined). G. Kirchhoff, B. Riemann, and J. C. Maxwell interpreted the quotient as the light velocity in vacuum. For Maxwell, the outcome of the 1855 experiment by Kohlrausch and Weber was the main basis for his electromagnetic theory of light of 1861 (see Refs. 6; 46; 25, Sect. 3.1; and 47).

Although Gauss published only his operational definition of magnetic fluid and intensity of the magnetic force (known today as magnetic field strength), he arrived, around 1835, at other essential results, as is evident from his posthumous works published in 1867 (see Ref. 48 pp. 630 and 637; Ref. 2, pp. 121 and 213; and Ref. 27, pp. 115-118). By combining Newton's second law of motion with his universal law of gravitation, assuming proportionality factors equal to 1 dimensionless, Gauss showed that the dimensions of the unit of mass are given by mm^3s^{-2} , which is the so-called astronomical system of measurement. By utilizing Biot-Savart's law

for the magnetic field of a current-carrying wire and adopting a dimensionless proportionality factor equal to 1, he arrived at the dimension of an electric current as $mm^{1/2}mg^{1/2}s^{-1}$. Later on, Weber greatly extended and developed these approaches.

The Magnetic Association

Gauss and Weber became a crucial part of the Humboldtian observational network. From this, resulted the Magnetic Association of Göttingen (Göttinger Magnetische Verein) (Refs. 10; 2, pp. 45 and 53; and 49). This association was the model for later international cooperation in the First Polar Year (1882-1883) and the International Geophysical Year (1957-1958) (Ref. 50). Gauss and Weber created a yearly publication for this Association, known as the "Resultate aus den Beobachtungen des Magnetischen Verein" (Results of the Observations Made by the Magnetic Association), in which the joint observations were collected and analyzed, and new appointment dates were made known. Six yearly volumes from 1836 until 1841 and an Atlas of Terrestrial Magnetism were published. These also contained instructions for the construction and use of instruments for the new magnetic observatories being erected. Such well-known works of Gauss as the "Allgemeine Theorie des Erdmagnetismus" of 1838 (General theory of terrestrial magnetism), and "Allgemeine Lehrsätze in Beziehung auf die im verkehrten Verhältnis des Quadrats der Entfernung wirkenden Anziehungs- und Abstossungskräfte" of 1839 (General propositions relating to attractive and repulsive forces acting in the inverse ratio of the square of the distance) first appeared in the *Resultate*. And in the annual volume for 1840, Weber first set down the absolute measure of the current intensity according to electromagnetic units.

The cooperation between Gauss and Weber which produced such beautiful results ended suddenly in 1837, with the *coup d'état* of the King of Hannover Ernst-August. Wilhelm Weber was one of the Göttingen Seven, the seven professors who protested against the arbitrariness of the monarch, and had to pay for their courageous action by dismissal from their university positions. Because of financial support from citizens with democratic-patriotic views, Weber was able to stay for some more years in proximity with Gauss, to remain active in the Magnetic Association of Göttingen, and to bring the work already begun to its conclusion. During his trip to England in 1838, Wilhelm Weber was able to meet John Herschel (son of William Herschel) and to convince him of the importance of the Magnetic Association. For his fundamental magnetic researches, Gauss received the Copley Medal in 1838. This was then the highest academic distinction, comparable with the present Nobel Prize (Ref. 51). Later, Weber also

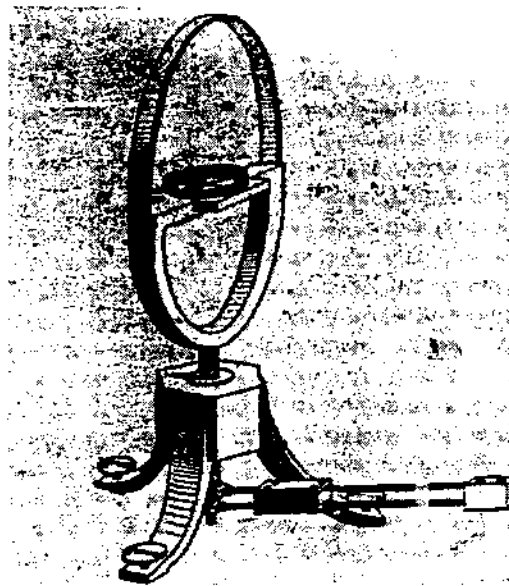

Wilhelm Weber's Werke, Vol. 3, p. 8.

The tangent galvanometer (Tangentenbussole). With this instrument, Wilhelm Weber carried out the first absolute measurements of electromagnetic currents in 1841. To make the current measurements, the horizontal component of the magnetic field of the Earth must be known, a quantity that was first determined by the magnetic researches which Gauss reported in his Intensity paper of 1832.

DETERMINING THE EARTH'S MAGNETIC FORCE: POISSON'S METHOD VERSUS GAUSS'S

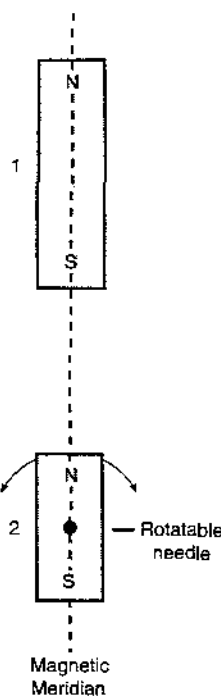

Poisson's Method
 In Poisson's method, the oscillations of the needle marked 2 will be accelerated by the presence of the fixed, first needle, in this configuration where the opposite poles are turned toward each other. A comparison of the number of oscillations in this configuration, to the number of oscillations when the first needle is removed, gives the ratio (M/H) of the magnetic force of the first needle to the horizontal intensity of the Earth's magnetic force.

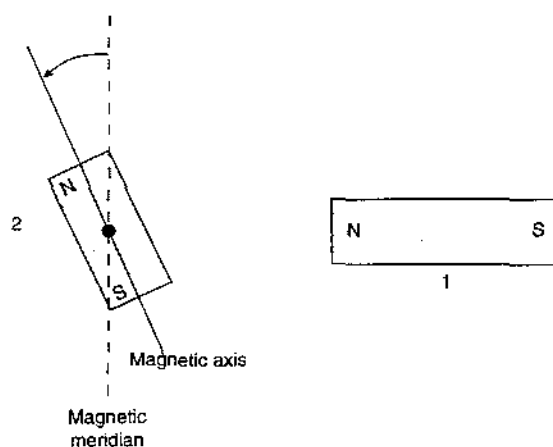

Gauss's Method
 But observations carried out by Poisson's method proved inaccurate. In the configuration conceived by Gauss, needle 1 tends to produce an angular deflection in the second, oscillating needle, while the Earth's magnetism attempts to return the second needle into a line with the magnetic meridian. The resulting angular deflection is proportional to the sought-for ratio M/H .

received the Copley Medal (Ref. 2, p. 184).

In 1842, Weber obtained a new position as physicist in Leipzig University. After the German Revolution of 1848-1849, which aimed at a greater political freedom and national unity, Weber was able to return to Göttingen University. But his work with Gauss was never continued. Weber retired from his official duties at the age of 70, but remained active in his researches until 1880. He died in Göttingen in 1891.

In the modern International System of Units, the unit of magnetic flux carries the name of weber, following a suggestion first presented by Clausius in 1882 (Ref. 2, p. 137). The unit gauss appears in connection with the density of magnetic flux or magnetic induction, namely, 1 tesla (T) = 10^4 gauss (G).

Andre Koch Torres Assis has been working for 15 years on Weber's electrodynamics, Ampère's force between current elements, and Mach's principle. He is the author of three books in English on these topics.

Karin Reich has studied mathematics, physics and astronomy. She has worked on the history of science at the Universities of Munich, Stuttgart, and Hamburg.

Karl Heinrich Wiederkehr studied physics, mathematics and chemistry at Hamburg University. He is the author of the only book-length biography of Wilhelm Weber, and many historical papers.

Assis (assis@ifi.unicamp.br) and Reich (reich@math.uni-hamburg.de) are at the Institut für Geschichte der Naturwissenschaften, Universität Hamburg, Bundesstr. 55, D-20146 Hamburg, Germany. Permanent address of Assis: Institute of Physics, State University of Campinas, 13083-970 Campinas, SP, Brazil. Wiederkehr, is at Birkenau 24, D-22087 Hamburg, Germany.

Acknowledgments

One of the authors (AKTA) wishes to thank the Alexander von Humboldt Foundation of Germany for a research fellowship during which this work was accomplished. He also thanks Laurence Hecht for permission to quote from the unpublished English translations of the works by Gauss, and by Kohlrausch and Weber.

Notes

- Key Words:** Magnetism and electromagnetism, absolute system of units, Weber's electrodynamics.
PACS: 01.65.+g (History of science), 06.20.Fn (Units and standards)
- Biographies of Gauss and Weber and discussions of their works with many references can be found in Refs. 1,2,3,4 (especially Vol. 1, Chapters 3, 6 and 7; and Vol. 2, Chapter 17), and Refs. 5, 6, and 7.
- For biographies of Ampère with references see, for instance, Refs. 22, 23, and 24. A discussion of Ampère's force between current elements and its integration for the force between current carrying wires with many references can be found in Refs. 25 and 26.
- In more general terms, Gauss presented this concept in Section 5 of the *Intensity* as follows: Let dm be the quantity of free magnetism in one particle with coordinates relative to three orthogonal axes as represented by x , y , and z . By definition the magnetic moment of the body is given by
$$\vec{M} = M_x \hat{x} + M_y \hat{y} + M_z \hat{z} = \iiint \vec{r} dm$$
 where the integral is over the whole body. The direction of \vec{M} is called the magnetic axis of the body.

References

- K. Reich, 1977. *Carl Friedrich Gauss—1777/1977*. (Munich: Heinz Moos Verlag).
- K.H. Wiederkehr, 1967. *Wilhelm Eduard Weber—Erforscher der Wellenbewegung und der Elektrizität (1804-1891)*, Volume 32 of *Grosse Naturforscher*, H. Degen (ed.). (Stuttgart: Wissenschaftliche Verlagsgesellschaft).
- A.E. Woodruff, 1976. "Weber, Wilhelm Eduard." In C.C. Gillispie, editor, *Dictionary of Scientific Biography*, Vol. 14, pp. 203-209. (New York: Scribner).
- C. Jungnickel and F. McCormmach, 1986. *Intellectual Mastery of Nature—Theoretical Physics from Ohm to Einstein*, Vols. 1-2. (Chicago: University of Chicago Press).
- T. Archibald, 1989. "Energy and the Mathematization of Electrodynamics in Germany, 1845-1875," *Archives Internationales d'Histoire des Sciences*, Vol. 39, pp. 276-308.

6. S. D'Agostino, 1996. "Absolute Systems of Units and Dimensions of Physical Quantities: A Link between Weber's Electrodynamics and Maxwell's Electromagnetic Theory of Light." *Physica*, Vol. 33, pp. 5-51.
7. K.H. Wiederkehr, 1997. "Carl Friedrich Gauss (1777-1855) und Wilhelm Weber (1804-1891)." In K.v.Meynn, editor, *Die Grossen Physiker*, Vol. 1, pp. 357-370 and 522-524. (München: Verlag C. H. Beck).
8. P. Honigmann, 1984. "Entstehung und Schicksal von Humboldts Magnetischem Verein (1829-1834) im Zusammenhang mit seiner Russlandreise." *Annals of Science*, Vol. 41, pp. 57-86.
9. K.-R. Biermann, 1971. "Der Brief Alexander von Humboldts an Wilhelm Weber von Ende 1831—ein bedeutendes Dokument zur Geschichte der Erforschung des Geomagnetismus." *Monatsberichte der Deutschen Akademie der Wissenschaften zu Berlin (DDR)*, Vol. 13, Heft 3, pp. 234-242.
10. K.H. Wiederkehr, 1964. "Aus der Geschichte des Göttinger Magnetischen Vereins und seiner Resultate." *Nachrichten der Akademie der Wissenschaften in Göttingen, II. Mathematisch-Physikalische Klasse*, Vol. 14, pp. 165-205.
11. K.H. Wiederkehr, 1973. "Das bisher unbekannte Gauss-Gutachten zur Wiederbesetzung des Göttinger Physiklehrstuhls 1831." *Gauss-Gesellschaft, Mitteilungen*, Vol. 10, pp. 32-47.
12. C.F. Gauss, 1841. "Intensitas vis magneticae terrestri ad mensuram absolutam revocata." *Commentationes Societatis Regiae Scientiarum Göttingensis Recentiores*, Vol. 8, pp. 3-44. Delivered before the Society in 15 December 1832. Also in C. F. Gauss's *Werke*, Vol. 5, pp. 79-118 (Göttingen: Königliche Gesellschaft der Wissenschaften (ed.), 1867).
13. C.F. Gauss, 1833. "Die Intensität der erdmagnetischen Kraft, zurückgeführt auf absolutes Maass." *Annalen der Physik und Chemie*, J. C. Poggendorff (ed.), Vol. 28, pp. 241-273 and 591-615.
14. C.F. Gauss, 1894. "Die Intensität der erdmagnetischen Kraft auf absolutes Maass zurückgeführt." In E. Dorn, editor, *Ostwald's Klassiker der exakten Wissenschaften*, Vol. 53. (Leipzig: Wilhelm Engelmann Verlag). Translation by Kiel, notes by E. Dorn.
15. C.A.F. Peters (ed.), 1862. *Briefwechsel zwischen C.F. Gauss und H.C. Schumacher*. (Altona: Gustav Esch.). Fourth volume.
16. U.C. Merzbach, 1984. *Carl Friedrich Gauss: A Bibliography*. (Wilmington, Del.: Scholarly Resources Inc.).
17. C.F. Gauss, 1995. "The Intensity of the Earth's Magnetic Force reduced to Absolute Measurement," translated from the German by Susan P. Johnson, edited by L. Hecht, unpublished.
18. L. Hecht, 1996. "Experimental Apparatus and Instrumentation," *21st Century*, Fall, pp. 35-40.
19. E.T. Whittaker, 1973. *A History of the Theories of Aether and Electricity*, volume 1: *The Classical Theories*. (New York: Humanities Press). First published 1910, revised and enlarged edition 1951, reprinted 1958.
20. A.M. Ampère, 1823. "Mémoire sur la théorie mathématique des phénomènes électrodynamiques uniquement déduite de l'expérience." *Mémoires de l'Académie des Sciences de l'Institut de France*, Vol. 6, pp. 175-387.
21. A.M. Ampère, 1965 [1823]. "On the Mathematical Theory of Electrodynamical Phenomena. Experimentally Deduced." In R. A. R. Tricker, *Early Electrodynamics—The First Law of Circulation*, pp. 155-200. (New York: Pergamon).
22. L.P. Williams, 1970. "Ampère, André-Marie." In C. C. Gillispie, editor, *Dictionary of Scientific Biography*, Vol. 1, pp. 139-147. (New York: Scribner).
23. C. Blondel, 1982. *A.-M. Ampère et la Création de l'Électrodynamique (1820-1827)*. (Paris: Bibliothèque Nationale).
24. L.P. Williams, 1989. "André-Marie Ampère," *Scientific American*, January, pp. 72-79.
25. A.K.T. Assis, 1994. *Weber's Electrodynamics*. (Dordrecht: Kluwer Academic Publishers). ISBN: 0-7923-3137-0.
26. M.d.A. Bueno and A.K.T. Assis, 2001. *Inductance and Force Calculations in Electrical Circuits*. (Huntington, New York: Nova Science Publishers). ISBN: 1-56072-917-1.
27. Cl. Schaefer, 1924-1929. "Über Gauss' Physikalische Arbeiten (Magnetismus, Elektrodynamik, Optik)," in Gesellschaft der Wissenschaften zu Göttingen, ed. Carl Friedrich Gauss *Werke*, Vol. 11, Part 2, pp. 1-217. (Berlin: Springer).
28. I. Newton, 1934 [1687]. *Mathematical Principles of Natural Philosophy*. (Berkeley: University of California Press). Cajori edition. Original publication in Latin in 1687.
29. A.K.T. Assis, 1999. *Relational Mechanics*. (Montreal: Apeiron). ISBN: 0-9683689-2-1.
30. A. Coulomb, 1935 [1785]. "First Memoir on Electricity and Magnetism," In W. F. Magie, ed., *A Source Book in Physics*, pp. 408-413. (New York: McGraw-Hill). Original publication in French in 1785.
31. A. Coulomb, 1935 [1785]. "Second Memoir on Electricity and Magnetism," In W. F. Magie, editor, *A Source Book in Physics*, pp. 413-420. (New York: McGraw-Hill). Original publication in French in 1785.
32. W. Weber, 1841. "Messung starker galvanischer Ströme bei geringem Widerstande nach absolutem Maasse." In C. F. Gauss and W. Weber, eds. *Resultate aus den Beobachtungen des magnetischen Vereins im Jahre 1840*, pp. 83-90. (Leipzig: Weidmannschen Buchhandlung). Also in Wilhelm Weber's *Werke*, Vol. 3, H. Weber, ed. (Berlin: Springer, 1893), pp. 6-12.
33. W. Weber, 1842. "Messung starker galvanischer Ströme nach absolutem Maasse." *Annalen der Physik und Chemie*, J. C. Poggendorff (ed.), Vol. 55, pp. 27-32. Also in Wilhelm Weber's *Werke*, Vol. 3, H. Weber, ed. (Berlin: Springer, 1893), pp. 19-23.
34. W. Weber, 1851. "Messungen galvanischer Leitungswiderstände nach einem absolutem Maasse." *Annalen der Physik und Chemie*, J.C. Poggendorff (ed.), Vol. 82, pp. 337-369. Also in Wilhelm Weber's *Werke*, Vol. 3, H. Weber, ed. (Berlin: Springer, 1893), pp. 276-300.
35. W. Weber, 1861. "On the Measurement of Electric Resistance according to an Absolute Standard." *Philosophical Magazine*, Vol. 22, pp. 226-240 and 261-269.
36. J.C. Maxwell, 1954 [1873]. *A Treatise on Electricity and Magnetism*. (New York: Dover). Original publication in 1873.
37. W. Weber, 1852. "Elektrodynamische Maassbestimmungen insbesondere Widerstandsmessungen." *Abhandlungen der Königl. Sächs. Gesellschaft der Wissenschaften, mathematisch-physische Klasse*, Vol. 1, pp. 199-381. Also in Wilhelm Weber's *Werke*, Vol. 3, H. Weber, ed. (Berlin: Springer, 1893), pp. 301-471.
38. W. Weber, 1846. "Elektrodynamische Maassbestimmungen—über ein allgemeines Grundgesetz der elektrischen Wirkung." *Abhandlungen bei Begründung der Königl. Sächs. Gesellschaft der Wissenschaften am Tage der zweihundertjährigen Geburtstagfeier Leibnizens herausgegeben von der Fürstl. Jablonowskischen Gesellschaft* (Leipzig), pp. 211-378. Also in Wilhelm Weber's *Werke*, Vol. 3, H. Weber, ed. (Berlin: Springer, 1893) pp. 25-214.
39. W. Weber, 1848. "Elektrodynamische Maassbestimmungen." *Annalen der Physik und Chemie*, J. C. Poggendorff (ed.), Vol. 73, pp. 193-240. Also in Wilhelm Weber's *Werke*, Vol. 3, H. Weber, ed. (Berlin: Springer, 1893), pp. 215-254.
40. W. Weber, 1966 [1852]. "On the Measurement of Electro-dynamic Forces." In R. Taylor, ed., *Scientific Memoirs*, Vol. 5, pp. 489-529. (New York: Johnson Reprint Corporation). Original published in 1852.
41. W. Weber and R. Kohlrausch, 1856. "Über die Elektrizitätsmenge, welche bei galvanischen Strömen durch den Querschnitt der Kette fliesst." *Annalen der Physik und Chemie*, J. C. Poggendorff (ed.), Vol. 99, pp. 10-25. Also in Wilhelm Weber's *Werke*, Vol. 3, H. Weber, ed. (Berlin: Springer, 1893), pp. 597-608.
42. W. Weber and R. Kohlrausch, 1996 [1856]. "On the Amount of Electricity which Flows through the Cross-section of the Circuit in Galvanic Currents." translated from the German by Susan P. Johnson, edited by L. Hecht, unpublished.
43. L. Hecht, 1996. "The Significance of the 1845 Gauss-Weber Correspondence." *21st Century*, Fall, pp. 22-34.
44. W. Weber, 1855. "Vorwort bei der Übergabe der Abhandlung: Elektrodynamische Maassbestimmungen, insbesondere Zurückführung der Stromintensitäts-Messungen auf mechanisches Maass." *Berichte über die Verhandlungen der Königl. Sächs. Gesellschaft der Wissenschaften zu Leipzig, mathematisch-physische Klasse*, Vol. 17, pp. 55-61. Also in Wilhelm Weber's *Werke*, Vol. 3, H. Weber, ed. (Berlin: Springer, 1893), pp. 591-596.
45. R. Kohlrausch and W. Weber, 1857. "Elektrodynamische Maassbestimmungen insbesondere Zurückführung der Stromintensitäts-Messungen auf mechanisches Maass." *Abhandlungen der Königl. Sächs. Gesellschaft der Wissenschaften, mathematisch-physische Klasse*, Vol. 3, pp. 221-290. Also in Wilhelm Weber's *Werke*, Vol. 3, H. Weber, ed. (Berlin: Springer, 1893), pp. 609-676.
46. K.H. Wiederkehr, 1994. "Wilhelm Weber und Maxwells elektromagnetische Lichttheorie." *Gesnerus*, Part. 3/4, Vol. 51, pp. 256-267.
47. A.K.T. Assis, 2000. "The Meaning of the Constant c in Weber's Electrodynamics." In R. Monti, ed., *Proc. of the Int. Conf. Galileo Back in Italy II*, pp. 23-36. (Bologna: Soc. Ed. Andromeda).
48. C.F. Gauss, 1877. *Carl Friedrich Gauss's Werke*, Vol. 5. (Göttingen: Königlichen Gesellschaft der Wissenschaften zu Göttingen, ed.). Second printing (first printing 1867).
49. W. Schröder and K.H. Wiederkehr, 2000. "Erdmagnetische Forschungen im 19. Jahrhundert." *Sudhoffs Archiv*, Vol. 84, Heft 2, pp. 166-183.
50. K.H. Wiederkehr, 2001. "Das Gauss-Observatorium für Erdmagnetismus und das erste Polarjahr 1882-1883." *Gauss-Gesellschaft, Mitteilungen*, Vol. 38, pp. 29-47.
51. K.H. Wiederkehr, 1982. "Über die Verleihung der Copley-Medaille an Gauss und die Mitarbeit Englands im Göttinger Magnetischen Verein." *Gauss-Gesellschaft, Mitteilungen*, Vol. 19, pp. 15-35.